

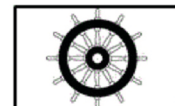

## *A-15 Tipi Kapı*



*A-0/A-15 tipi bölmelerde kullanılır.*



2690 / 17



## *A-15 Tipi Kapıların Teknik Özellikleri*



**Yangın Sınıfı** ..... : A-15



**Kalınlık** ..... : 42 mm



**Standart Genişlik (Net Açıklık)** ..... : 700 mm



**Standart Boy (Net Açıklık)** ..... : 1900 mm

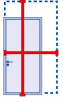

**Üretilbilir Boyutlar (Net Açıklık)** ..... : 900 x 1600 mm  
800 x 1800 mm  
700 x 2000 mm



**Yüzey Sac Kalınlığı** ..... : 1,00 mm



**Kapı Yüzeyi** ..... : GLV, PSL



**İzolasyon Malzemesi** ..... : Kayayünü - Rockwool / Denmark



**Kayayünü Yoğunluğu** ..... : 130 kg/m<sup>3</sup>



**Ağırlık** ..... : ~59 kg/ad (700 x 1900 mm)



**Uygulama** ..... : Sac perdeye monte edilir.



**Sertifika [IMO Resolution A.754(18)]** ..... :  Bayrak Otoritesi (TC Denizcilik Müsteşarlığı)



Fransız Loydu (Bureau Veritas)



Türk Loydu



MED Marine Equipment Directive (EC)

## A-15 Tipi Kapıların Montajı

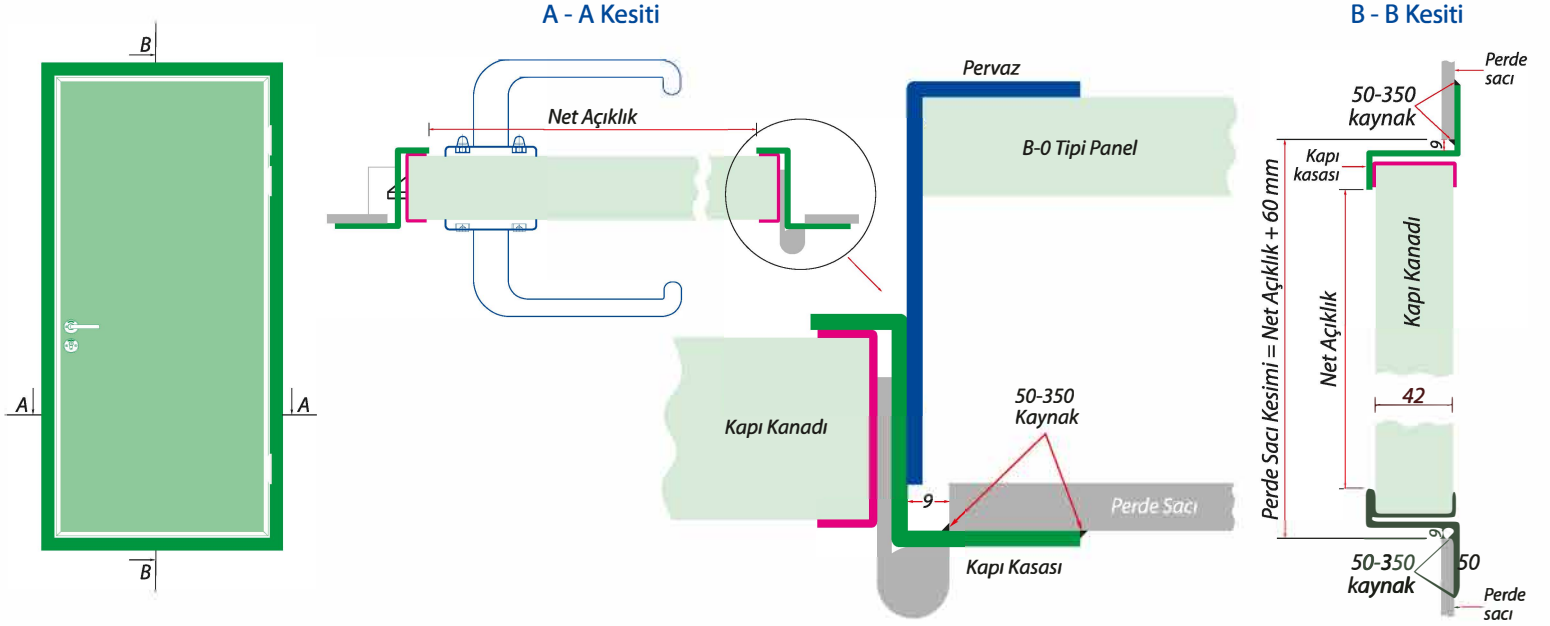

### Montaj Kuralları

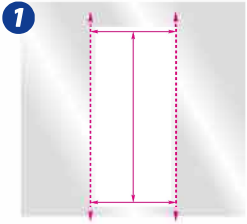

1 Perde sacının "Net Açıklık + 60 mm" ölçüsünde kesilip kesilmediğine bak.

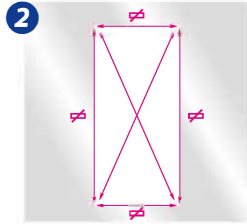

2 Kesilen sac yüzeylerinin aynı düzlemde olup olmadığını kontrol et.

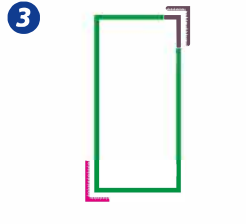

3 Montajdan önce kasanın gönyesini kontrol et.

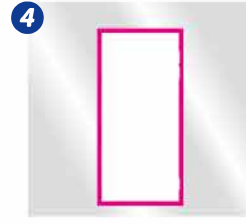

4 Kasayı kapı boşluğuna yerleştir.

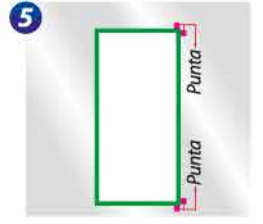

5 Kasayı, menteşeli kenarın alt ve üst noktalarından perde sacına puntala.

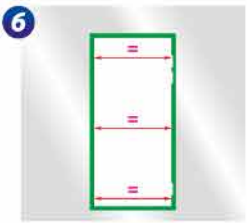

6 Kasanın orta genişliğini ölç; üst ve alt genişlik ölçüleri ile aynı olup olmadığına bak.

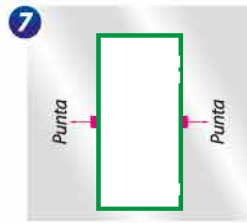

7 Kasayı her iki uzun kenarının orta noktasından perde sacına puntala.

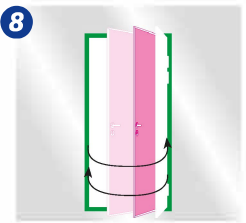

8 Kanadı yerine tak ve iyi çalışıp çalışmadığına bak.

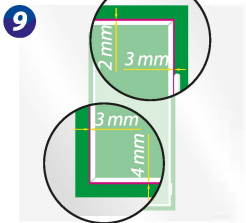

9 Kanadın kenarları ile kasa arasındaki boşluğun düzgün olup olmadığına ve kanadın kasaya düzgünce oturup oturmadığına bak.

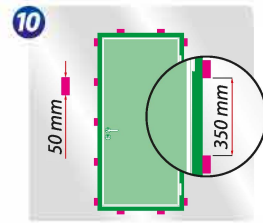

10 350 mm aralıklarla ve 50 mm dikiş uzunluğunda, kasayı, bir yüzünden perdeye kaynat.

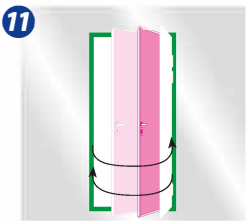

11 Kanadın rahat çalışıp çalışmadığını tekrar kontrol et.

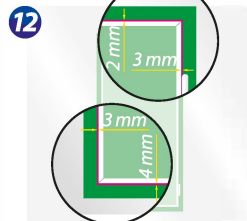

12 Kanat ile kasa arasındaki boşluğun düzgünlüğünü yeniden kontrol et.

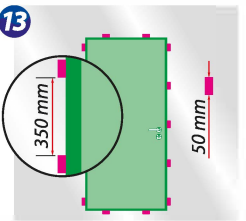

13 Kasayı; 350 mm aralıklarla ve 50 mm dikiş uzunluğunda, diğer yüzden perdeye kaynat.

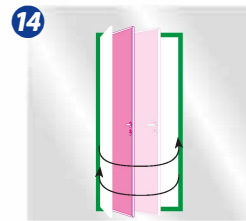

14 Son kontrollerini yap.

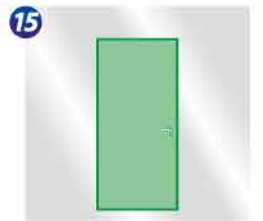

15 Montaj işlemi tamamlanmıştır.

## A-15 Tipi Kapıların Avantajları



**Çabuk ve kolay**  
monte edilir.



**Kapı kasaları**  
elektrostatik toz  
boyalı **Z profildir.**



**Kilitler içten**  
**kutu**  
**korumalıdır.**



**Galvaniz kapılar,**  
istenilen **reng**  
**boyanabilir.**

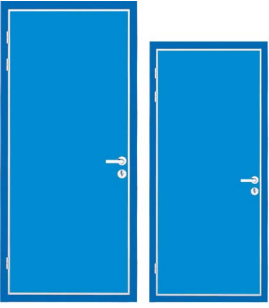

**Standart boyutlarda**  
üretilmektedir. **İstenilen**  
**boyutta** üretilebilir.

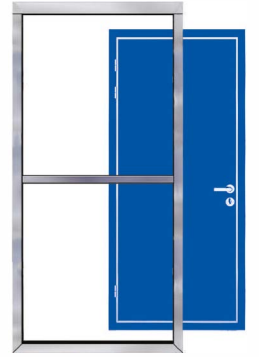
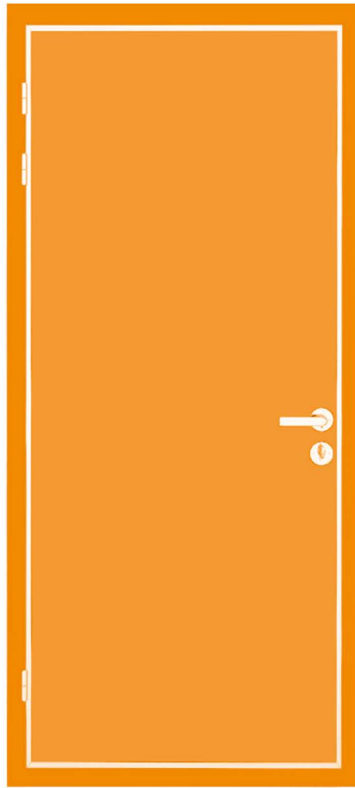

**Kapı kanadı;**  
**takviyeli**  
**iskeletlidir.**

**Üç menteşelidir.**  
Kapı kanadında  
sarkma olmaz.

**Menteşeler paslanmaz**  
malzemeden **tek parça**  
olarak üretilmektedir.

**Kapı kanadı**  
**paslanmaz U**  
profil ile çevrilidir.

**Menteşe yerleri**  
içten  
**takviyelidir.**

**Kapı kolları ve**  
aynaları tamamen  
**paslanmazdır.**

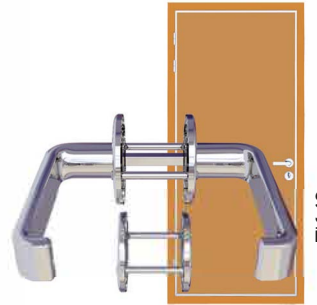
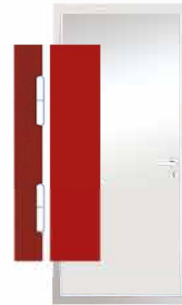
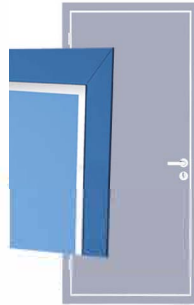

TK-12