

B-15 Tipi Kapı

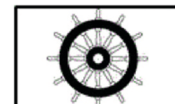

B-15 tipi bölme panelleriyle kullanılır.



2690 / 17



B-15 Tipi Kapıların Teknik Özellikleri



Yangın Sınıfı : B-15



Kalınlık : 42 mm



Standart Genişlik (Net Açıklık) : 700 mm



Standart Boy (Net Açıklık) : 1900 mm

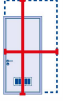

Üretilbilir Boyutlar (Net Açıklık) : 850 x 1750 mm
800 x 1900 mm
700 x 2000 mm



Yüzey Sac Kalınlığı : 0,6 mm



Kapı Yüzeyi : PVC, GLV, PSL



PVC Film : PVC film “düşük alev yayma” sertifikalıdır.



İzolasyon Malzemesi : Kayayünü - Rockwool / Denmark



Kayayünü Yoğunluğu : 130 kg/m³



Ağırlık : ~59 kg/ad (700 x 1900 mm)



Uygulama : B-15 tipi duvar panellerine monte edilir.



Sertifika [IMO Resolution A.754(18)] :  Bayrak Otoritesi (TC Denizcilik Müsteşarlığı)



Fransız Loydu (Bureau Veritas)



Türk Loydu



MED Marine Equipment Directive (EC)

B-15 Tipi Kapıların Montajı

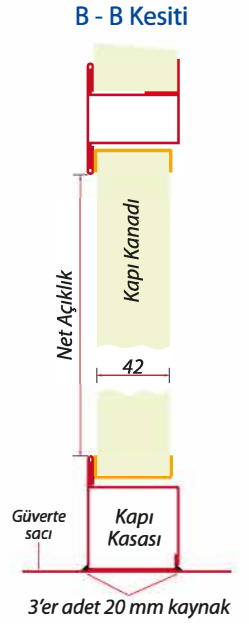
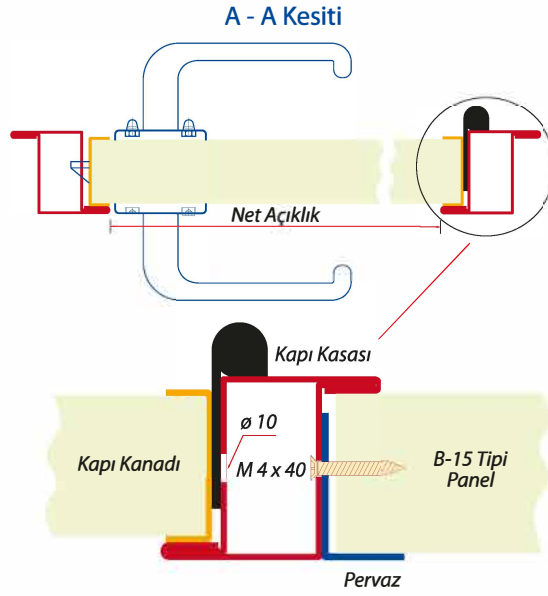
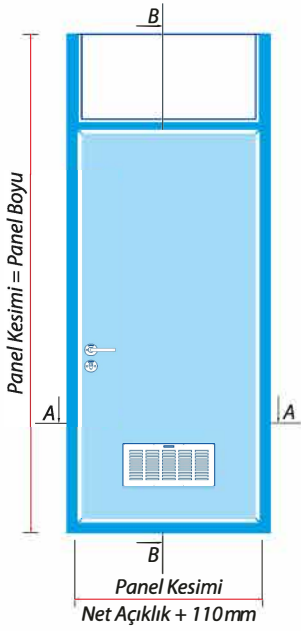

Montaj Kuralları

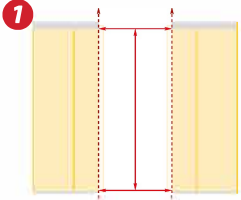

1- Panelin doğru ölçüde kesilip kesilmediğine ve kapı boşluğunun köşe noktalarının aynı düzlemde olup olmadığına bak.

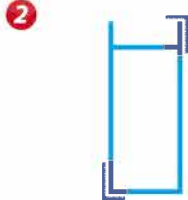

2- Montajdan önce kasanın gönyesini kontrol et.

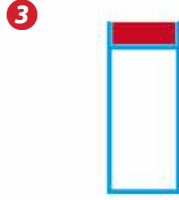

3- Parça duvar panelini yerleştir.

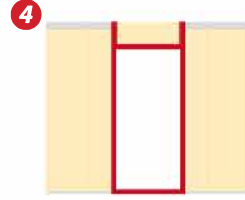

4- Kasayı kapı boşluğuna yerleştir.

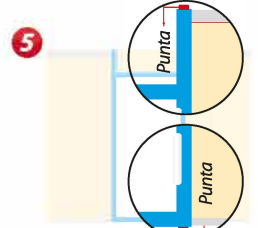

5- Pannle teması sağlayarak kasayı menteşeli kenarın alt ve üst noktalarından güverteye puntala.

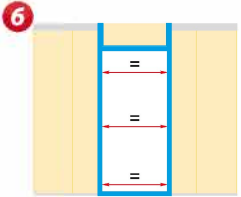

6- Kasanın orta genişliğini ölç ve üst ve alt genişlik ölçüleri ile aynı olup olmadığına bak.

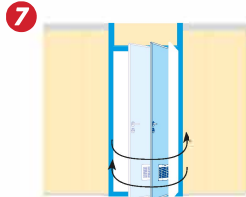

7- Kanadı yerine tak ve iyi çalışıp çalışmadığına bak.

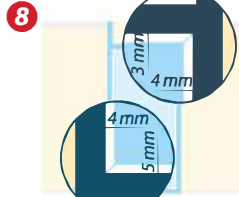

8- Kanadın kenarları ile kasa arasındaki boşluğun düzgün olup olmadığına ve kanadın kasaya düzgünce oturup oturmadığına bak.

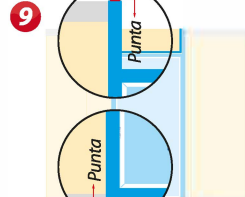

9- Kasayı, kol-kilit kenarının alt ve üst noktalarından güverteye puntala.

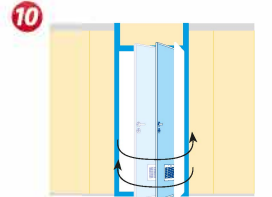

10- Kanadın tekrar rahat çalışıp çalışmadığını kontrol et.

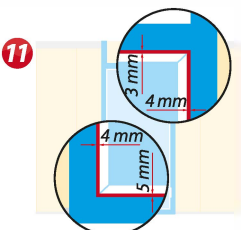

11- Kanat ile kasa arasındaki boşluğun düzgünlüğünü yeniden kontrol et.

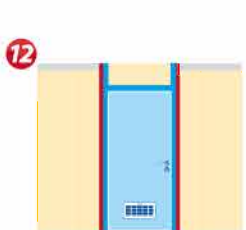

12- Herşey olumlu ise kapı pervazını yerine tak.

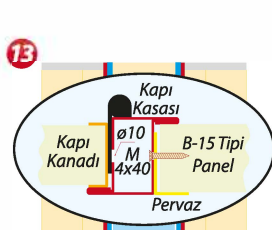

13- Kasanın ve pervazın panellerle sıkı sıkıya temasını sağlayarak kasayı montaj deliklerinden pervaza vidala.

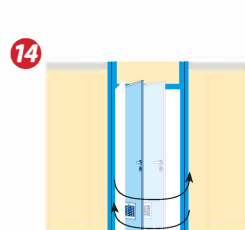

14- Son kontrollerini yap.

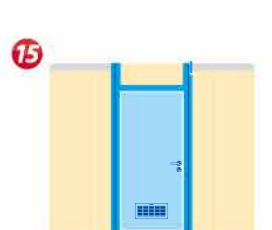

15- Montaj işlemi tamamlanmıştır.

B-15 Tipi Kapıların Avantajları



Çabuk ve kolay
monte edilir.



Kapı kasaları elektrostatik
toz boyalı **kutu profildir.**



Kilitler içten
kutu korumalıdır.



Zengin renk
seçenekleri mevcuttur.



Standart boyutlarda
üretilmektedir. **İstenilen**
boyutta üretilebilir.

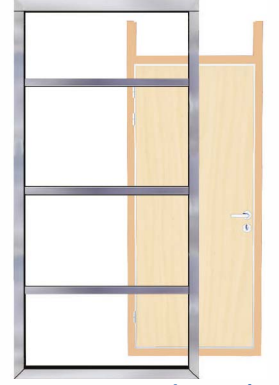

Kapı kanadı;
takviyeli
iskeletlidir.



PVC yüzeyler, kirlenme
ve çizilmeye karşı
koruyucu film ile
kaplanmıştır.



Kapı kolları ve
aynaları tamamen
paslanmazdır.

Üç menteşelidir.
Kapı kanadında
sarkma olmaz.

Menteşeler paslanmaz
malzemeden **tek parça**
olarak üretilmektedir.

Menteşe yerleri
içten
takviyelidir.

Standart modellerde
havalandırma
ızgarası bulunur.

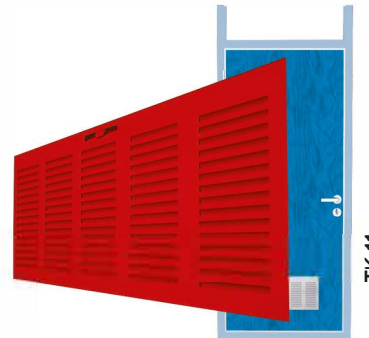

TK-11